



EXP 6900

OWNER'S MANUAL

900 MHz technology

offers you extended

range and

superior performance.

Uniden®

Contents

Introduction	2	Ringer Tone and Volume.	8
Features	2	Setting the Handset Earpiece Volume	8
Included with Your EXP 6900 Phone	3	Using Your Phone	8
Controls and Functions	4	Making and Receiving Calls	8
Installation	5	• Storing a Number in Memory	8
• Charging the Battery Pack	5	• Entering a Pause in Memory Dialing	9
Charging the Handset	5	• Storing Mixed Tone/Pulse Numbers	9
Low Battery Indicator	5	• Dialing a Stored Number	9
Cleaning the Battery Contacts	5	• One-Touch Dialing	9
• Selecting a Location	5	• Chain Dialing	9
• Setting the Dial Mode Switch	5	• Erasing a Stored Number	9
• Desk or Tabletop Installation	6	• Replacing a Stored Number	9
• Wall Installation	6	• Selecting a Different Channel	10
Setting the Handset Retainer for Wall Mounting	6	• Using the Flash Button	10
Mounting on a Standard Wall Plate	6	• Using the Page/Find Feature	10
Mounting Directly on a Wall	7	Troubleshooting	11
Setting Up Your Phone	8		
• Raising the Antenna	8		
• Adjusting Ringer/Volume Controls	8		

Introduction

The Uniden® EXP 6900 900 MHz cordless phones are designed and engineered to exacting standards for reliability, long life, and outstanding performance.

▼ Features

- 900 MHz Extended Range Technology
- 10-Number Memory Dialing
- 3 “One-Touch Priority” Keys
- Desk or Wall Mountable
- Tone/Pulse Dialing
- Handset Volume Control
- 32 Digit Redial
- Page/Find
- AutoTalk™
- AutoStandby™
- 7 Hours Talk Time
- Hearing Aid Compatible

The EXP 6900 features include *AutoTalk* and *AutoStandby*. *AutoTalk* allows you to answer a call by just removing the handset from the base so you don't have to waste time pushing buttons or flipping switches. *AutoStandby* allows you to hang up by simply returning the handset to the base.

The *UltraClear Plus* true compander circuitry virtually eliminates background noise. This innovative technology, together with 40 different channels, provides you with the best possible reception during all your conversations.

To protect you against misbilled calls which might result from your phone being activated by other equipment, the EXP 6900 has *Random Code™* digital security which automatically selects one of over 65,000 digital security codes for the handset and base. Also, the *AutoSecure™* feature electronically locks your phone when the handset is in the base.

To get the most from your phone, please read this owner's manual thoroughly. Also, be sure to complete the product registration form and mail it in.

Be sure to visit our web site at: www.uniden.com.

Included with Your EXP 6900 Phone

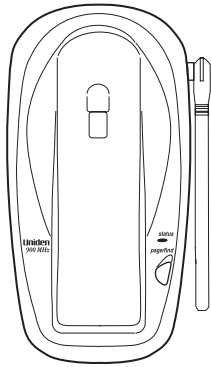

Base

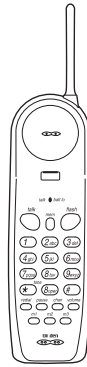

Handset

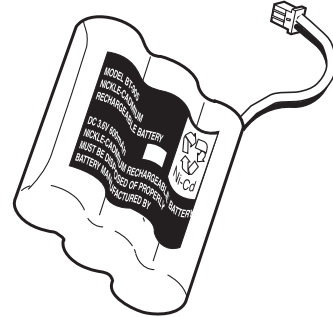

Rechargeable Battery

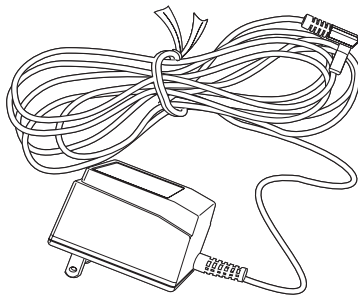

AC Adapter

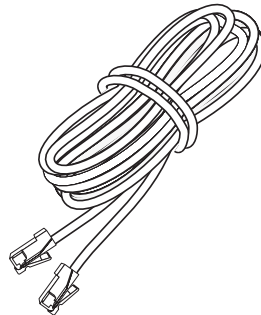

Telephone Cord

Also included:

- This Owner's Manual
- Other Printed Material
- Precautions and Important Safety Instructions

If any of these items are missing or damaged, contact the Uniden Parts Department at (800) 554-3988, 8:30 a.m. To 5:00 p.m. Central, Monday through Friday, or contact us on the web at www.uniden.com.

Controls and Functions

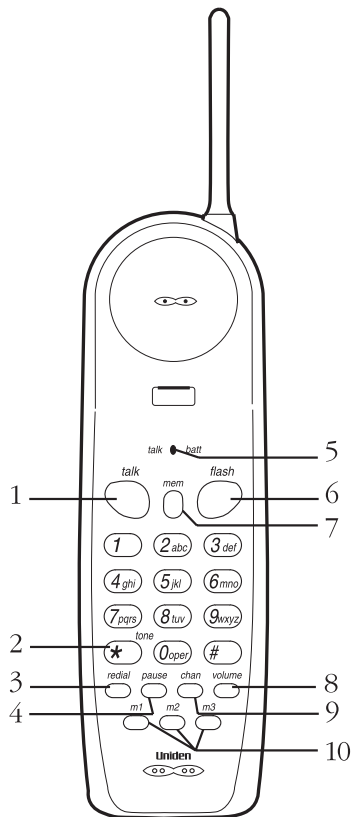

1. **talk** - answers or places calls
2. ***tone** - switches to tone dialing in pulse dial mode
3. **redial** - redials the last number
4. **pause** - adds a timed pause in a memory dialing sequence
5. **talk/batt** - LED indicates when phone is in use or the battery is low
6. **flash** - accesses call waiting (if available)
7. **mem** - enters or recalls numbers in memory
8. **volume** - sets both the ringer and earpiece volumes
9. **chan** - selects another channel for clearer reception
10. **m1, m2, m3** - accesses stored numbers in memory locations 1, 2, and 3 for one-touch dialing
11. **handset retainer** - holds handset in base for wall mounting
12. **status** - LED indicates the phone is in use or the handset is charging
13. **page/find** - locates the handset

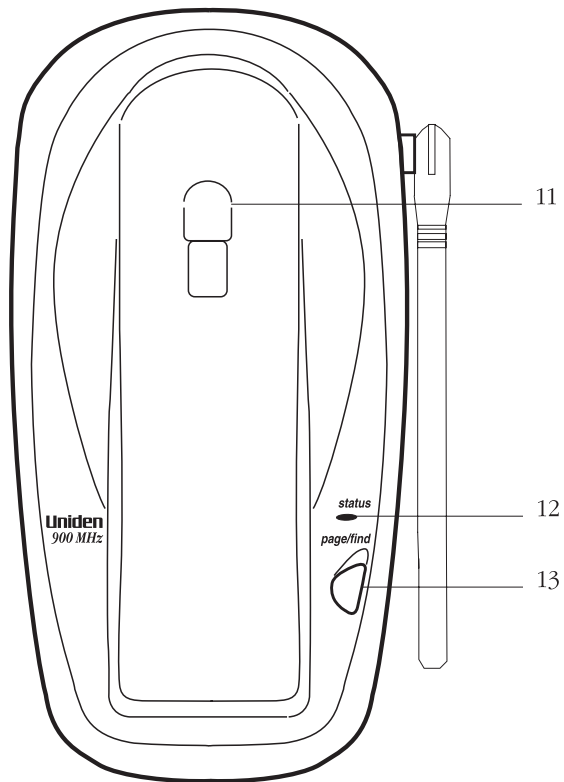

Installation

Charging the Battery Pack

The rechargeable Nickel-Cadmium battery pack must be fully charged before using your phone for the first time. **Before plugging the phone line into your new phone, you must charge the battery for approximately 15-20 hours without interruption.**

1. Remove the handset battery cover.
2. Plug the battery's cable into the handset and place the battery pack inside the battery compartment.

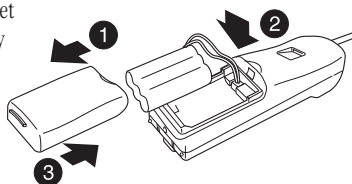

The plastic connectors will fit together only one way. Make sure the battery's connector is properly aligned. Use only the Uniden battery pack (model BT-905).

3. Replace the battery cover.

▼ Charging the Handset

Place the handset on the base to charge. *(The handset can charge in either the face-up or face-down position.)*

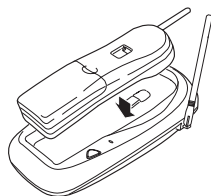

▼ Low Battery Indicator

When the battery pack in the handset is low and needs to be charged, the **batt** LED flashes every 3 seconds.

If this occurs while you are on the phone, you will hear an alert tone. Complete your call as quickly as possible and return the handset to the base for charging.

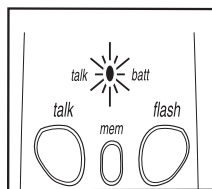

▼ Cleaning the Battery Contacts

To maintain a good charge, it is important to clean all battery contacts on the handset and base about once a month. Use a dry cloth or other contact cleaner.

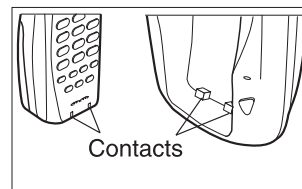

Do not use any liquids or solvents.

Selecting a Location

Before choosing a location for your new phone, there are some important guidelines you should consider:

- The location should be close to both a phone jack and continuous power outlet.



A continuous power outlet is an AC outlet which does not have a switch to interrupt its power.

- Keep the base unit and handset away from sources of electrical noise such as motors or fluorescent lighting.
- Be sure there is sufficient space to rotate the base unit antenna to fully vertical.



Important: Do not place the power cord in an area where it may create a trip hazard or become chafed and create a fire or electrical hazard.

Setting the Dial Mode Switch

Place the switch in the **T** position for tone dialing, or the **P** position for pulse dialing.

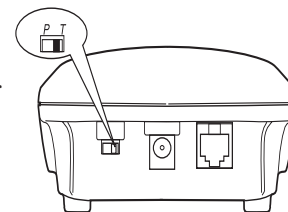

Desk or Tabletop Installation

1. Plug the AC adapter cord into the 9V DC input jack on the base.
2. Wrap the AC adapter cord inside the molded strain-relief.

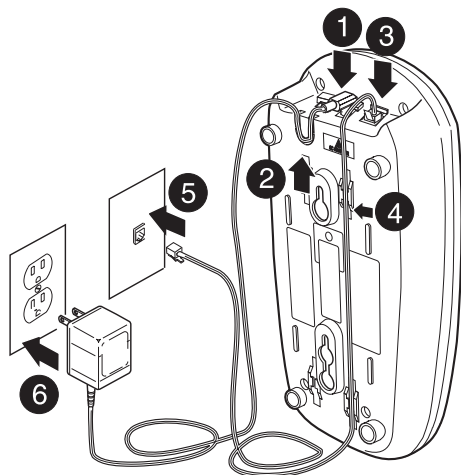

3. Plug one end of the long telephone cord into the **TEL LINE** jack on the base.
4. Place the telephone cord into the right molded channel cord holder.
5. Plug the other end of the telephone cord into the telephone wall jack. (*Remember, the phone must be fully charged before you can use it.*)
6. Plug the AC adapter into a standard 120V AC wall outlet that is not controlled by a wall switch.



Use only the AC adapter that came with the phone.

7. Raise the antenna on the base.

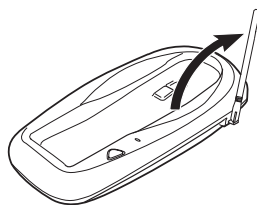

Wall Installation

▼Setting the Handset Retainer for Wall Mounting

1. Remove the handset retainer on the base by sliding it upward.

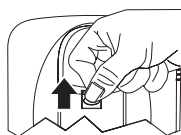

2. Flip the retainer over so the tab is facing up.



3. Slide the retainer back onto the base.

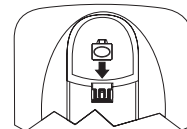

▼Mounting on a Standard Wall Plate

The phone is designed to be mounted on a standard wall plate.

1. Plug the AC adapter into the base.
2. Place the AC adapter cord inside the left molded channel cord holder.
3. Plug a short telephone cord into the **TEL LINE** jack on the base.

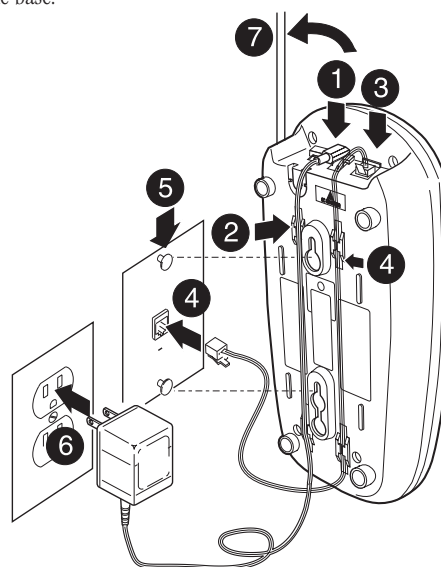

4. Place the telephone cord into the right molded channel cord holder and plug the other end of the cord into the wall jack. (*Remember, the phone must be fully charged before you can use it.*)
5. Place the base on the two posts of the wall plate and slide downward to secure.
6. Plug the AC adapter into a standard 120V AC wall outlet that is not controlled by a wall switch.



Use only the AC adapter that came with the phone.

7. Raise the antenna on the base.

▼ Mounting Directly on a Wall

If you do not have a standard wall plate, you can mount the phone directly on a wall. Before mounting your cordless telephone, consider the following:

Select a location away from electrical cables, pipes, or other items behind the mounting location that could cause a hazard when inserting screws into the wall.

Make sure the wall material is capable of supporting the weight of the base and handset; otherwise, damage to the unit could result.

Use #10 screws (minimum length of 1 3/8 inches) with anchoring devices suitable for the wall material where the base will be placed.

1. Insert the screws, with their appropriate anchoring devices, 3 5/16 inches apart. Allow 3/16 of an inch between the wall and screw heads for mounting the phone.

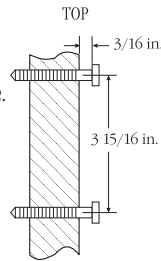

2. Plug the AC adapter into the base.
3. Place the AC adapter cord inside the left molded channel cord holder.
4. Plug one end of the long telephone cord into the **TEL LINE** jack on the base.
5. Place the telephone cord into the right molded channel cord holder.
6. Place the base on the screws and push down until it's firmly seated.
7. Plug the other end of the telephone line into the telephone wall jack. (*Remember, the phone must be fully charged before you can use it.*)
8. Plug the AC adapter into a standard 120V AC wall outlet that is not controlled by a wall switch.



Use only the AC adapter that came with the phone.

9. Raise the antenna on the base.

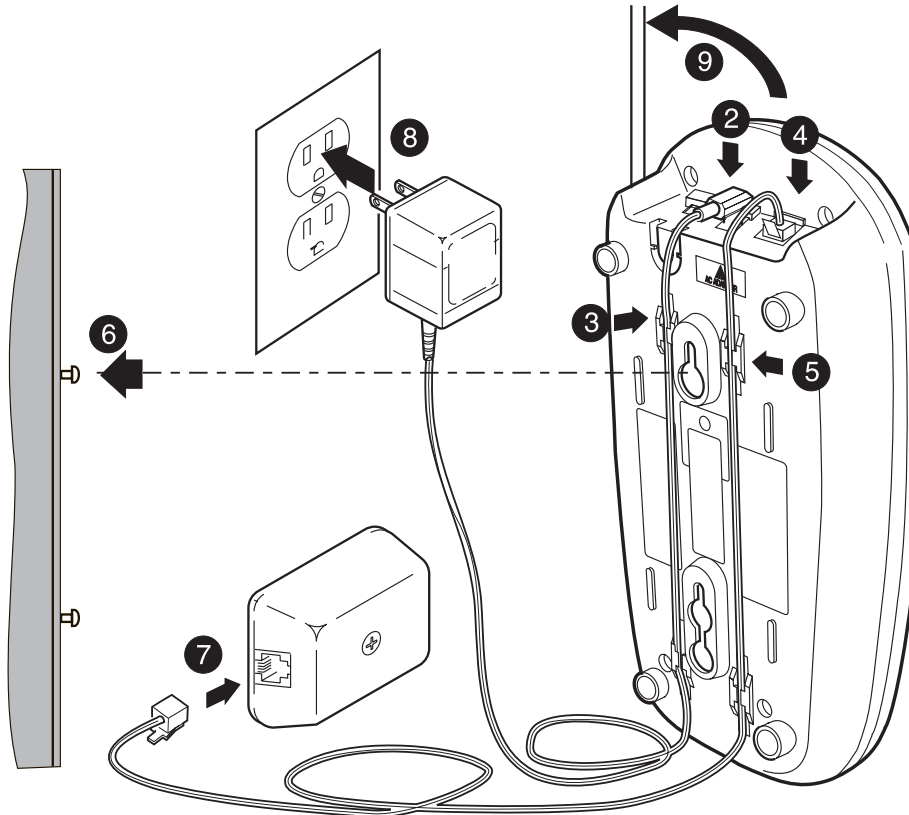

Setting Up Your Phone

Raising the Antenna

Before using your phone, be sure to raise its antenna to the vertical position.

Adjusting Ringer/Volume Controls

▼ Ringer Tone and Volume

1. While the phone is not in use, press **volume**.
2. The phone has two ringer tones, each with two volume levels. Press **volume** again until you hear the ringer tone and volume level you want.

▼ Setting the Handset Earpiece Volume

1. While you are on a call, press **volume**.
2. The phone has three receiver volume levels: Normal, High, and Loud. Press **volume** again until you hear the volume level you want.

When you hang up, the phone keeps the last volume setting selected.

Using Your Phone

Making and Receiving Calls

	Handset on Base	Handset off Base
Answer call	When the phone rings, remove the handset from the base. (<i>AutoTalk</i>)	Press any key.
Make call	<ol style="list-style-type: none"> 1. Remove the handset from the base and press talk 2. The talk LED lights. 3. Listen for the dial tone. 4. Dial the number. 	<ol style="list-style-type: none"> 1. Pick up the handset and press talk 2. The talk LED lights. 3. Listen for the dial tone. 4. Dial the number.
Hang up	Return handset to the base. (<i>AutoStandby</i>)	Press talk .
Redial	<ol style="list-style-type: none"> 1. Remove the handset from the base and press talk. 2. Listen for the dial tone. 3. Press redial to dial the number. 	<ol style="list-style-type: none"> 1. Pick up the handset and press talk. 2. Listen for the dial tone. 3. Press redial to dial the number.

Storing a Number in Memory

Your EXP 6900 phone has 10 memory locations for storing important telephone numbers.

1. Remove the handset from the base and press **mem**. The **talk** LED flashes and you hear a beep.
2. Enter the phone number you want to store (up to 16 digits).



You have 20 seconds after pressing **mem** to enter the number you wish to store. Otherwise, an error tone will sound.

3. Press **mem** and enter a number (0-9) on the keypad for the memory location you want to use.

You hear a long beep and the **talk** LED goes out indicating the number has been stored successfully.

If you select any keys other than 0-9, the handset will beep rapidly and no number will be stored.



You cannot store numbers in **m1**, **m2**, or **m3**. Refer to "One-Touch Dialing."

Entering a Pause in Memory Dialing

If you would like to use a phone number stored in memory to access voice mail, for example, you can store a pause in the phone number sequence.

To use this function, follow *steps 1 and 2* in “Storing a Number in Memory,” then press the **pause** button on the handset to place a pause in the phone number sequence.



*Remember, the phone number you wish to store cannot have more than 16 digits, including the pause. (The **pause** button counts as one digit.)*

Follow the remaining steps in the “Storing a Number in Memory” section to complete the operation.

Storing Mixed Tone/Pulse Numbers

If your phone is set up for pulse dialing, you can store a mixed mode number (up to 16 digits) to easily access long distance services.

1. Remove the handset from the base and press **mem**. The **talk** LED flashes and you hear a beep.
2. Enter the number to be dialed in pulse mode.
3. Press the ***tone** button on the handset. The ***tone** button counts as one digit and enters a pause.
4. Enter the number(s) to be dialed in tone mode.
5. Press **mem** and a number (0-9) on the keypad for the memory location you wish to use. You hear a long beep and the **talk** LED goes out.

Dialing a Stored Number

To dial a phone number stored in memory, press **talk**, then press **mem** and the memory location (0-9). Your phone will dial the stored number.



If you select a memory location that does not have a stored number, the handset will beep rapidly and the phone will not dial.

One-Touch Dialing

Your phone is equipped with three “One-Touch Priority” keys for instant dialing (**m1**, **m2**, and **m3**). **You cannot store phone numbers directly into m1, m2, and m3.** They are only used to dial phone numbers stored into memory locations 1, 2, and 3 on the keypad.

1. To instantly dial phone numbers stored in memory locations 1, 2, or 3, simply press **m1**, **m2**, or **m3**. (There is no need to press **talk** the phone will automatically dial.)
2. If no phone number was stored in memory locations 1, 2, or 3 on the keypad, pressing **m1**, **m2**, or **m3** will do nothing.

Chain Dialing

After dialing a number you may be requested to enter a special access code, for example, when performing a banking transaction.

1. Store the access code into one of the memory locations (0-9).
2. Dial the main number.
3. Press **mem** and the memory location of the access code at the appropriate time.

Erasing a Stored Number

1. Remove the handset from the base.
2. Press **mem** twice.
3. Press the memory location number (0-9) you want to clear. You hear a long beep confirming that you have erased the number.

Replacing a Stored Number

Remember, your EXP 6900 phone has 10 memory locations, represented by the numbers 0-9 on the keypad. If you store a phone number in one of these locations, then attempt to store a different number in the same location later, the new number **will replace** the previous one.

Selecting a Different Channel

If you encounter interference while using your phone, you can manually change the phone's channel for clear operation. Interference can come from appliances or other phones in your home. This function works only when the phone is in use.

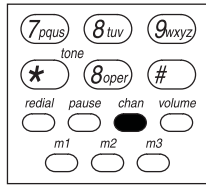

During the course of a conversation, if you hear static or noise which makes it difficult to hear, press **chan**. The **talk** LED flashes, indicating the phone is changing to another channel.

Using the Flash Button

Use **flash** for accessing services such as call waiting. If you receive a call during your conversation, press the **flash** button on the handset. Press **flash** again to return to the previous call.

Using the Page/Find Feature

The Page/Find feature sends a signal from the base to the handset causing it to beep. This is useful for locating the handset when it is away from the base. To use this feature, press **page/find** on the base. The handset beeps for 60 seconds. (*Press and hold the page/find button to get a continuous beep.*)



The paging feature does not work when the phone is in use.

On the handset press **talk** to end the page. Press **talk** again if you do not wish to make a call.

Troubleshooting

If your EXP 6900 cordless telephone is not performing to your expectations, please try these simple steps. If you are still unable to resolve the problems, contact your place of purchase or call customer service at (800) 297-1023.

Caution: *Do not attempt to service this unit yourself. Servicing must be performed by qualified personnel.*

Problem	Suggestion
The status LED won't come on when handset is placed in base.	<ul style="list-style-type: none">• Make sure the AC adapter is plugged into the base and wall outlet.• Make sure the handset is properly seated in the base.• Make sure the rechargeable battery pack is properly connected in the handset.• Make sure that the charging contacts on the handset and on the base are clean.
The audio sounds weak and/or scratchy.	<ul style="list-style-type: none">• Make sure that the base antenna is in the vertical position.• Press chan to help eliminate background noise.• Move the handset and/or base to a different location away from metal objects or appliances and try again.
Can't make or receive calls.	<ul style="list-style-type: none">• Check both ends of the telephone line cord.• Make sure the AC adapter is plugged into the base and a wall outlet.• Disconnect the AC adapter for a few minutes, then reconnect it.• Reset security code by placing the handset back on the base for a few seconds. The status LED will blink indicating that the phone has been reset.
Handset doesn't ring or receive a page.	<ul style="list-style-type: none">• The Nickel-Cadmium battery pack may be weak. Charge the battery for 15-20 hours.• The handset may be too far away from the base.• Place the base away from appliances or metal objects.• Reset security code by placing the handset back on the charging cradle for a few seconds. The status LED will blink indicating that the phone has been reset.

THANK YOU

FOR PURCHASING A UNIDEN PHONE!

Uniden®

Covered under one or more of the following U.S. patents:

4,511,761 4,523,058 4,595,795 4,797,916 5,381,460 5,426,690
5,434,905 5,491,745 5,533,010 5,574,727 5,650,790 5,660,269
5,661,780 5,663,981 5,671,248 5,717,312 5,754,407 5,768,345
5,787,356 5,838,721

© February 2000 Uniden America Corporation

All rights reserved • Printed in China • UCZZ01231GZ